

Varenummer: 0109032  
 Beskrivelse: Seeger låsering AS 16X1.5  
 Fjederstål  
 Note: Monteres med ZGA tang

## Mål

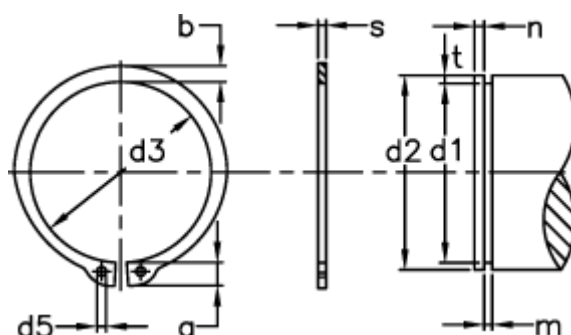

a max	= 5.0	d5 min	= 2.0	s	= 1.50
AN mm <sup>2</sup>	= 19.6	FN kN	= 3.26	t	= 0.40
B	= 2.25	FRg kN	= 4.5	Tang	= ZGA-1
b	= 2.5	FR kN	= 16.7	tol	= -0.06
Betegnelse	= AS 16	g	= 1.0	tol	= +0,10 -0,36
d1	= 15.2	m min	= 1.60	tol	= -0.11
d2	= 16	n abl x 1000	= 48	vægt kg/1000	= 1.20
d3	= 14.7	Nominel træk	= 1.2		